

# Mechatronic design and analysis of a modular developed exoskeleton for rehabilitation purposes

Mehmed Yüksel<sup>1</sup>, Luis Manuel Vaca Benitez<sup>1</sup>, Dinmukhamed Zardykhan<sup>1</sup> and Frank Kirchner<sup>1,2</sup>

<sup>1</sup> German Research Center for Artificial Intelligence (DFKI) - Robotics Innovation Center (RIC)  
firstname.lastname@dfki.de

<sup>2</sup> Department of Mathematics and Computer Science, University of Bremen

<sup>1, 2</sup> Robert-Hooke-Str. 1 - 28359 Bremen, Germany

## Abstract

**Recupera is a novel exoskeleton robot designed for therapy and rehabilitation purposes. The project is primarily aimed at aiding patients suffering post-stroke consequences providing means for daily therapy and exercises. Developing such a system brings many design challenges, which can be tackled through introducing modularity, based on knowledge base design into the system. In this paper we focus on the description of the electrical modularity and the analysis of the electrical performance during impedance control experiments with the upper body.**

## 1. Introduction

With the average life expectancy increasing day by day, the population of elderly people is expected to be growing in the next decades [1]. According to the Global Stroke Organization's statistical analysis as the population grows older, the occurrence of stroke incidents becomes higher [2]. Being not only one of the most common cause of mortality, stroke is also a major cause of disability worldwide [3]. Full or partial loss of various motor skills is one of most common post-stroke impairments encountered. There are various rehabilitation strategies existing nowadays, among which task/context specific training shows to be more effective in reducing the impairment [4]. However, due to the rehabilitation being a very demanding process both time- and effort-wise, there is an emerging challenge in providing appropriate services to the patients [3]. It has been shown that exoskeletons are able to provide rehabilitation training with no significant difference from other non-robotic strategies [5]. According to the survey on robotic devices for upper-body rehabilitation [6] there are over 120 various robotic devices. These devices can be divided into two major types based on the mechanical design: [7] end-effector based (e.g. MIT Manus [8], CRAMER [9], NeReBot [10]) and exoskeleton based (e.g. CAREX [11], SUEFUL-6 [12], WOTAS [13]). In end-effector-based robots the patients hand is attached to a hand interface of a manipulator following trajectories that simulate natural arm movements. Exoskeletons are wearable robots, meaning that the complete arm can be guided. When comparing both structures, exoskeletons seem to be more attractive than the counterpart due to the ability to perform more complex movements of patient's joints with less risk of injuries for the patient. Due to the fact that exoskeletons attempt to mimic anthropomorphic motions the structure is inherently complex especially in the shoulder joint [14]. The complexity drastically increases with the number of patient's joints needed to be actuated. Up to date there are only few commercially available rehabilitation

exoskeletons capable of controlling the whole arm e.g. ARMin III [15], T-WREX [16], InMotion ARM (previous name InMotion 2.0, Interactive Motion Tech., Inc.; based on: MITManus [8]).

When dealing with exoskeletons one of the important tasks is to keep the structure configurable, so that the system can be adjusted to different body proportions of different patients. Therefore, smaller, wearable, non-stationary, functional devices are more preferable as compared to bulky, cumbersome machines. This work introduces the new light-weight, wearable, multi-functional, mobile exoskeleton Recupera with 28 active degrees of freedom. Aimed at upper-body rehabilitation, Recupera was built keeping a modularity concept in mind, which means: Same electric actuator type (brushless DC motor (BLDC)) was used throughout the robot, the hardware parts are replaceable and identical software/control concepts were used throughout the entire system. This makes the whole system design simpler and reproducible.

## 2. Formalism and model based design

Taking the complexity of systems and individuality of consumers into consideration it becomes very challenging to develop a generalized system from the hardware perspective. Formalisms of concepts and model based design are common tools when approaching a design of a new system. The D-ROCK project at "DFKI" is aiming at improving the overall design efficiency and work on a generalization of the design and development process. The Recupera exoskeleton was designed according to the methodology used in D-ROCK. This methodology is based on rules summarized and illustrated in Figure 1:

- The control and behaviour design of components, modules and subsystems should be done in correspondence with well defined mathematical models.
- A configurator and a configuration language have to be used in order to create the formalization of the robot.
- The control and behaviour designs should pass plausibility checks both virtually and physically in order to validate the functionality.
- The manufacturing and assembling data should be done in a specific format, which includes full description of all hardware standards of the system to be met.

Moreover, the model based software allows the customization of the robot with the help of the modular design. Such parameters as: size, shape and functionality of the robot can be defined in advance and sent to the developer or a factory. In

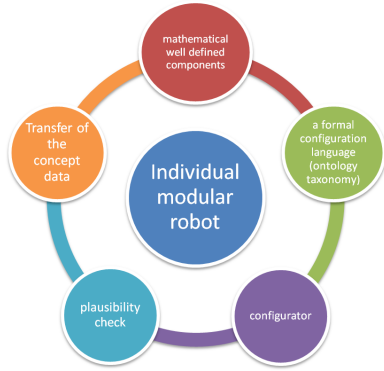

**Figure 1.** The steps for the configuration to manufacturing processes of an individual robot

this way, the known existing soft- and hardware parts can be prepared for a specific individual request.

### 2.1. Recupera Taxonomy and D-Rock Ontology

During the development of complex systems it is necessary to establish a solid knowledge base covering all related covered domains. Knowledge base can be extensive in size and most of the time need categorization. Using taxonomy [17] is a way to introduce a hierarchical classification to the knowledge base without making complex relations. The taxonomy of Recupera's electrical design is constructed taking mechanical design and the robot control applications into consideration (see in Figure2).

The exoskeleton includes four sub-systems dedicated to the upper and lower body, backpack and external components. These sub-systems are classified in a modular structure in accordance with mechatronical design explained in Section 3. An ontology in a computer science domain is a semantic explicit description of classes and concepts with their interrelation [18]. Most of the ontology methods cover the application domain, some of the existing methods are SIARAS [19], ROSETTA [19] and KnowRob [20]. D-ROCK ontology aims at encompassing both hardware and application domains, and is used for the Recupera exoskeleton project.

An example configuration of a power source for the Recupera backpack with knowledge based configuration is given in Table 1 to visualize the formal description, which is based on Recupera taxonomy and D-ROCK ontology, as follows:

$$R = \{ \text{internalbattery} \sqsubseteq \text{energysource}, \\ \text{energysource} \sqsubseteq \text{powerunit}, \text{powerunit} \sqsubseteq \text{backpack}, \\ \text{backpack} \sqsubseteq \text{Recupera} \} \\ \text{type\_1\_KoBa\_battery} \equiv \text{internalbattery}$$

## 3. Technical Description of the Recupera Exoskeleton

Recupera Exoskeleton is a complex robotic system with 28 independent BLDC actuators, 4 servo motors and 2 assistance motors, their supplies as well as the robot control system are equipped with sensors (positions encoders, force-torque (FT) sensors, current measurement sensors, capacitive tactile sensors) used for the autonomous mobile operation with embedded biosignal processing [21]. Figure 3 gives an overview of the

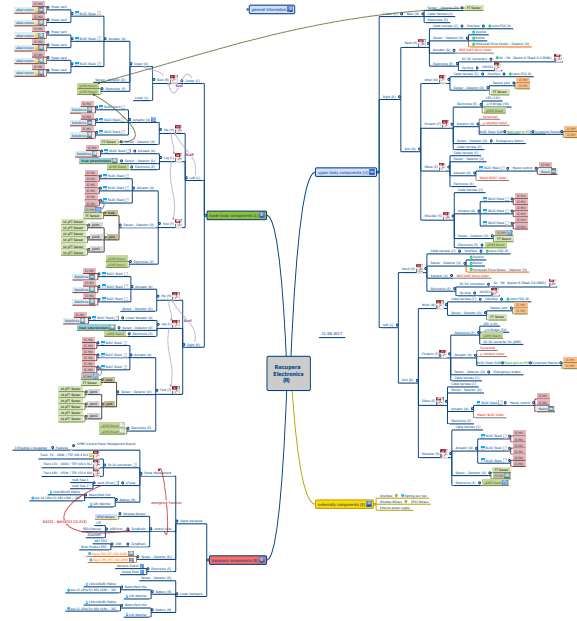

**Figure 2.** The taxonomy of Recupera electronic components conforming to structural design.

electro-mechanical components within the Recupera Exoskeleton. Not to juxtapose the system and scenario complexities (e.g. partial, half or full body skeleton usabilitys) and keep the structural and electrical design simple, the system was developed in compliance with the modularization and modelling concept of D-ROCK<sup>1</sup> framework and ontology. This ontology includes well defined mathematical components written in a formal configuration language and used for its properties, relationship in hardware (mechatronical) and software domains. This framework contains configurations of different robot types with plausibility check, detection of redundancy and recognition problems.

According to D-ROCK ontology and Recupera taxonomy as well of as the use-case scenario of the robot the electronic design of the system is separated into four different sub classes, which are: back components, upper body components, lower body components and external components (see in Figure 2).

### 3.1. The upper body

The upper body is one of the two sub-systems of the Recupera Exoskeleton which consists of two exoskeleton arms and the back structure. Within the structure there is a removable hand part with water-protected, quick-release, electromechanical connectors which provide support for the motion of the fingers using a servo motor, as well as measures the acting force of gripping using a force sensor. This also play a role of a human-machine-interfaces (HMI) for the system. The upper body of the exoskeleton is equipped with three shoulder- and one elbow BLDC motor (see Table 2 placed on each arm). The motors are driven by Field-Programmable-Gate-Arrays (FPGAs) developed at "DFKI RIC" and powered by Brushless-DC (BLDC) control electronics [22]. These actuators support signal acquisition with local processing providing the low-level control.

<sup>1</sup>D-ROCK: Models, methods and tools for the model based software development of robots. See for more information: <http://robotik.dfk-bremen.de/en/research/projects/d-rock.html>

System layer	Recupera exoskeleton consists of a robot-body (of upper- and/or lower-body/ies) and a <b>back-pack</b> and an external auxiliary unit.
Subsystem layer	The <b>backpack</b> consists of the control electronics and communication unit and <b>power unit</b> .
Module layer	The <b>power unit</b> consists of the <b>energy source</b> and voltage converter and energy distributor and power management
Components layer	The <b>energy source</b> consists of the <b>internal battery</b> and the external power source
Definition of the component (internal battery)	<ul style="list-style-type: none"> <li>• The type 1 KB battery pack is a battery.</li> <li>• It consists of Li-Polymer battery cells, a capacity of <math>5000m.A</math> and the cell configuration of 12S1P.</li> <li>• It has a nominal voltage of <math>44.4V</math> minimum voltage of <math>40.8V</math> maximum voltage of <math>50.4V</math>.</li> <li>• It has a capacity of <math>10Ah</math> and a maximum discharging current of <math>150A</math> and a short term peak current of <math>250A</math> and a fuse of <math>t25A</math>.</li> <li>• It has a connector, type axial module , <math>70A</math>, 2 Pole, male, for power connection, on the connector position 1.</li> <li>• It has a connector, type high density connector, <math>10A</math>, 25 pole, male, for charging&amp;balancing , on the connector position 2.</li> <li>• Its dimensions are <math>287.30 \times 146.50 \times 42</math> mm.</li> </ul>

**Table 1.** Formal description of the hierarchical classification of the internal battery in knowledge base related to Recupera taxonomy. The battery information influences the application scenario as well as the mechatronical construction. The system, subsystems, module layers scopes in detail the exoskeleton design. The definition of components (here internal battery) describes the properties of the used battery pack.

Also, the FPGAs include cascaded control consisting of position, velocity and current loops, and also take care of the safety limits for position and current. The communication between BLDC stacks in the upper and lower body chains is realized by HSERCOMM (High Speed Serial Communication) developed at "DFKI RIC" and is capable of communicating with a data rate up to  $320Mbit$ . In addition, the local communication, such as acquiring readings from force torque (FT) sensors (e.g. for measurement of the acting force on/from patient) or the communication with hand section, is performed via the low voltage differential signaling (LVDS) and serial communication. The electrical system was designed to be capable of reaching a peak consumption of  $1440W$  (see in Table 3 with an estimated nominal power consumption of the upper body is  $288W$ ). The upper body of Recupera exoskeleton is designed and constructed as mountable on a lower body or a wheel for different medical training purposes and applications to support the patient mobility (see in Figure5) and the modular design of the exoskeleton

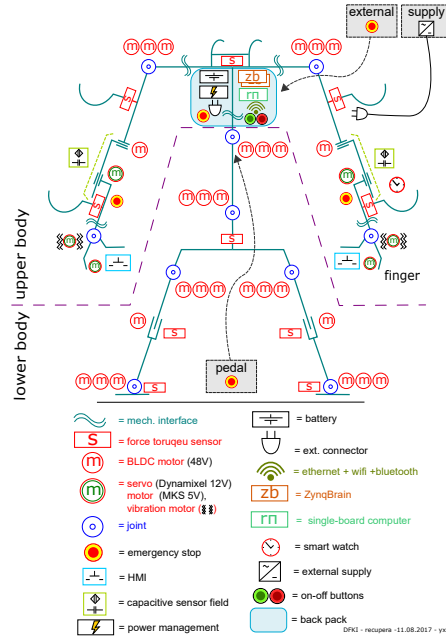

**Figure 3.** Plan of mechatrical structure within the Recupera Exoskeleton robot.

enables decoupled use of the arms and hands.

position	quantity	motor type	gear info	electrical power
shoulder	2x3	ILM50x8	strain wave gearing 100:1	155W
elbow	2x1	EC45Flatt	strain wave gearing 100:1	50W
lower arm	2x1	MX servo	193:1	35W
back hexapod	6	AT01500M	ball screw (1,5mm pitch)	211.2W
hip	2x3	ILM70x10	strain wave gearing 100:1	270W
leg	2x1	ILM38x12	ball screw (2mm pitch)	168W
foot	2x3	ILM50x8	strain wave gearing 100:1	155W

**Table 2.** The list of electric motors as electrical load on the Recupera exoskeleton robot

### 3.2. The lower body

The communication and power supply design of the lower body sub-system has a similar design to the upper body. The system includes an hexapod with 6 linear actuators ("DFKI RIC"), on each side of lower sub-system the active hip and ankle joints are actuated by 3 BLDC motors each forming almost-spherical parallel mechanisms [23]. Between hip and ankle joints a linear actuator ("DFKI RIC") for active adjustable leg length and walking is mounted (see in Table2). In addition, there are 4 force torque (FT) sensors used for the measurement

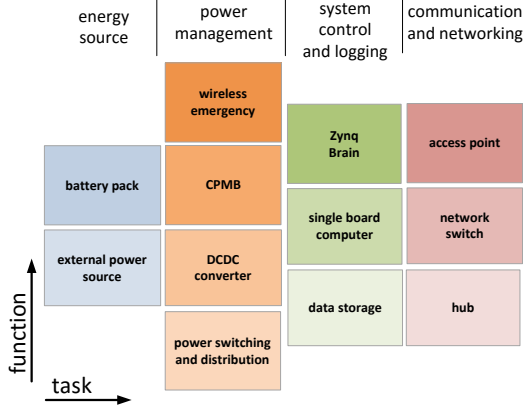

**Figure 4.** The simplified task and functions of the backpack components of Recupera exoskeleton

of the acting forces from/on patient. The estimated nominal power consumption for the lower body is  $1200W$ . The electrical system was designed to be capable of reaching a peak consumption of  $2500W$  (see Table 3).

circuit voltage	nominal current (upper/lower body)	peak current (upper/lower body)
5V	5A/1A	20A/2A
12V	3A/1A	10A/2A
48V	6A/25A	30A/50A

**Table 3.** Estimated energy consumption of the Recupera Exoskeleton robot.

### 3.3. The back pack

The power supply and control of the exoskeleton is provided through a backpack, which is the third sub-system of the robot. The backpack is designed keeping the modularity criteria and encloses: the energy source, power management, system control and logging, as well as the communication and networking components (see in Figure 4).

The power electronics of the Recupera Exoskeleton are supplied by a main voltage of  $48V$  designed to drive the robot sub-systems from 3 independent different power sources, which are: the main power battery, the auxiliary system battery and the external power supply with on-system charging feature. The CPMB (Central Power Management Board) designed by "DFKI RIC", provides the switching of the power sources and is responsible to cut off the connection of the  $48V$  power bus in emergency cases. The stop buttons providing the emergency signal for CPMB are located on: arms of upper body, back pack and a wireless emergency stop. In cases of emergency the system is supplied by additional  $5V$  and  $12V$  auxiliary buses. The battery types chosen for the system are LiPolymer and LiFePO4 type with  $5000mAh$  capacity and  $30C$  discharge current, giving the system enough power to operate the full body for 15-20 min. The estimated energy consumption of the Recupera Exoskeleton robot is summarized in Table 3. For safety reasons the design of the battery has a special "quick-release" feature, which enables a possibility to cut off the power of the system manually. This feature also supports the usability of the system

for extended therapy sessions. The "OnBoardCharger" option provides the charging and balancing of the batteries on the system. Two multi-eFuse cards are used on the backpack unit for the distribution and limitation of the power bus, auxiliary bus for the whole exoskeleton and for the measurement of the current of these buses.

The centralized control architecture topology has evolved in the last years into a heterogeneous network structure [24]. With heterogeneous processing unit network different tasks from signal acquisition to heavy computing tasks will be managed by local pre-processing, which will increase the safety and robustness of the Recupera Exoskeleton system with an avoidance of processing load and utilization of network capacity. Two "ZynqBrain" control units ("DFKI RIC") equipped with System-on-a-Chip (SoC) FPGA, embedded dual core "ARM Cortex A9" which are responsible for the adaptive kinematics, dynamic control with biosignal monitoring and data acquisition. All this is a combination of serial and parallel data handling on the Recupera Exoskeleton Robot. An additional single board computer ensures the logging of system data and also acts as a simple HMI interface. A wireless access point, an additional network switch and USB hubs with Bluetooth adapter are used for communication and networking with different applications and purposes.

### 3.4. The external components

The last part of the sub system of Recupera exoskeleton are: external power source and wireless emergency system. Apart from the mobile applications the external power source is used for the development under laboratory conditions and for on-board charging. The wireless emergency button based on  $868MHz$  sends stop signals to the CPMB band. This is considered as a extra safety measure.

## 4. Experiments and Results

In order to evaluate the power consumption of the Recupera part system, and thus the performance of the mechatronical modules, data was recorded during impedance control experiments. The system was supplied with  $48V$ . Since the exoskeleton is mainly torque-controlled, a force-based impedance controller was implemented.

$$F = M_T \ddot{X} + D_T \dot{X} + K_T (X_d - X) \quad (1)$$

A target impedance can be obtained in a general ideal case via equation 1.  $M_T$ ,  $D_T$  and  $K_T$  are the inertia, damping and stiffness coefficients. Further are  $\ddot{X}$ ,  $\dot{X}$  and  $X$  the real acceleration, velocity and position terms of the system joints respectively.  $X_d$  represents a desired position to be held. This control law regulates simultaneously both position and force by specifying a target dynamic relationship between them.

$$F = D_T \dot{X} + K_T (X_d - X) \quad (2)$$

However, for the experiments a simplified variant of the force-based impedance controller described above was used including only the damping and the stiffness terms, and is represented by equation 2.

The chosen parameters for the experiments where  $D_T = 4 \frac{Ns}{m}$  and  $K_T = 35 \frac{N}{m}$ . The joints of the arms were set to hold certain desired positions  $X_d$ . Then the upper arm joints (3 shoulder- and one elbow joint each side) were manually pushed down against gravity until the joints could not be moved fur-

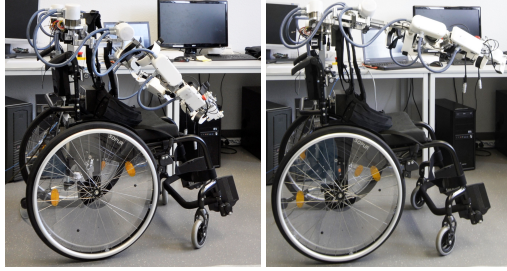

**Figure 5.** Part system of Recupera exoskeleton, which is temporary mounted on a wheel chair for testing of upper limb support functions (left: lower position when pushed down, right: upper position to be held)

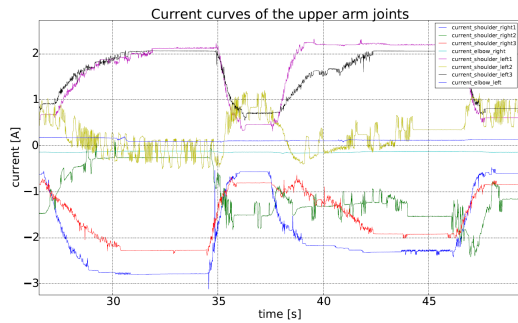
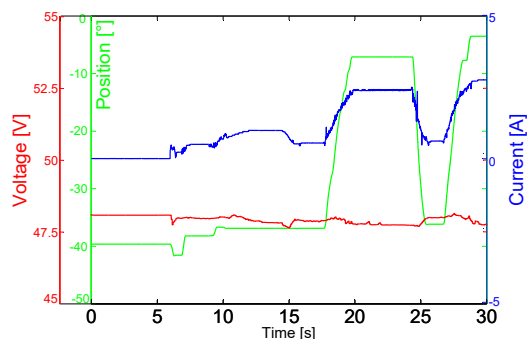

**Figure 6.** Current curves of the eight upper arm joints during an impedance control experiment

ther, resulting in a higher power consumption. The range of movement can be visualized in Figure 5.

Figure 6 shows the current curve of the upper arm joints. It can be seen that the maximal value reached by a single joint lies around  $-2.8A$ . The total current pulled sums up to  $505mA$  when all joints were being pushed at the maximal lower position, and briefly reaching around  $1A$  when letting the joints move back to the reference position, according to the measurement at the power supply.

In order to analyse the system behaviour in a deeper manner Figure 7 shows the relationship between, the current, voltage and the angular position on the basis of the first shoulder joint of the right arm. It can be seen that the desired position to be held by the impedance controller was around  $-43^\circ$ . The joint was pushed up to  $-7^\circ$  and later to  $-4^\circ$  reaching current values



**Figure 7.** Position-current-voltage curves of the first right shoulder joint during an impedance control experiment

of  $2.5A$ . No significant drops in the current curve can be seen, not even when the joint velocity was high, e.g. when going back to the desired position. The voltage curve however shows some deviations from the  $48V$ . This is most likely due to power loss over the connection tree. This deviations in the voltage values can actually be seen in all upper body joints, in which values going from  $47.37V$  up to  $48.27V$  could be measured.

## 5. Conclusion

In this paper we presented the ontology-taxonomy based design of the modular developed exoskeleton robot "Recupera" for rehabilitation purposes, focusing mainly on the electronics. Furthermore an analysis of the power characteristics of the system in an impedance control setup was presented. The experiment shows that even with the arm joints working under power intensive conditions the total power consumption of the upper body system stays far below the planned  $6A$ . Naturally the  $6A$  were planned for the whole body system. So when the lower body modules are integrated to the mechatronical system the power consumption will rise. Furthermore, increasing the impedance controller gains, specially the stiffness, would result in a smaller movement range and in a higher power consumption when pushing the joints away from the reference position. This kind of tests, as well as experiments with the full body exoskeleton, and the corresponding power analysis are work for the future. However the experimental results presented in this contribution allow to expect that the designed power characteristics of  $48V / 6A$  will easily suffice even after the mentioned changes. This confirms the benefits of using a well structured modular design based on proper formalisms, ontologies and taxonomies on such a complex system.

## 6. Acknowledgments

This work has been performed within the projects "RECUPERA-Reha" and "D-Rock", which are funded by the German Space Agency (DLR Agentur) with federal funds of the Federal Ministry of Education and Research (Grant Nr.01IM14006A and Grant Nr.01IW15001)

## 7. References

- [1] V. Kontis, J. E. Bennett, C. D. Mathers, G. Li, K. Foreman, and M. Ezzati, "Future life expectancy in 35 industrialised countries: projections with a Bayesian model ensemble," *The Lancet*, vol. 389, no. 10076, pp. 1323–1335, apr 2017.
- [2] A. G. Thrift, T. Thayabaranathan, G. Howard, V. J. Howard, P. M. Rothwell, V. L. Feigin, B. Norrving, G. A. Donnan, and D. A. Cadilhac, "Global stroke statistics," *International Journal of Stroke*, vol. 12, no. 1, pp. 13–32, 2017.
- [3] G. A. Donnan, M. Fisher, M. Macleod, and S. M. Davis, "Stroke," *The Lancet*, vol. 371, no. 9624, pp. 1612–1623, May 2008.
- [4] P. Langhorne, F. Coupar, and A. Pollock, "Motor recovery after stroke: a systematic review," *The Lancet Neurology*, vol. 8, pp. 741–754, 2009.
- [5] A. Lo, P. D. Guarino, L. G. Richards, J. K. Haselkorn, G. F. Wittenberg, D. G. Federman, R. J. Ringer, T. H. Wagner, H. I. Krebs, B. T. Volpe, C. T. Bever, D. M. Bravata, P. W. Duncan, B. H. Corn, A. D. Maffucci, S. E. Nadeau, S. S. Conroy, J. M. Powell, G. D. Huang,

- and P. Peduzzi, "Robot-Assisted Therapy for Long-Term Upper-Limb Impairment after Stroke," *New England Journal of Medicine*, vol. 19362, no. 13, pp. 1772–83, 2010.
- [6] P. Maciejasz, J. Eschweiler, K. Gerlach-Hahn, A. Jansen-Troy, and S. Leonhardt, "A survey on robotic devices for upper limb rehabilitation," *Journal of NeuroEngineering and Rehabilitation*, vol. 11, no. 1, p. 3, Jan 2014.
- [7] A. Frisoli, L. Borelli, A. Montagner, S. Marcheschi, C. Procopio, F. Salsedo, M. Bergamasco, M. C. Carboncini, M. Tolaini, and B. Rossi, "Arm rehabilitation with a robotic exoskeleton in virtual reality," in *2007 IEEE 10th International Conference on Rehabilitation Robotics*, June 2007, pp. 631–642.
- [8] N. Hogan, H. I. Krebs, J. Charnnarong, P. Srikrishna, and A. Sharon, "Mit-manus: a workstation for manual therapy and training i," in *[1992] Proceedings IEEE International Workshop on Robot and Human Communication*, Sep 1992, pp. 161–165.
- [9] S. J. Spencer, J. Klein, K. Minakata, V. Le, J. E. Bobrow, and D. J. Reinkensmeyer, "A low cost parallel robot and trajectory optimization method for wrist and forearm rehabilitation using the Wii," in *2008 2nd IEEE RAS & EMBS International Conference on Biomedical Robotics and Biomechanics*. IEEE, October 2008, pp. 869–874.
- [10] G. Rosati, P. Gallina, and S. Masiero, "Design, Implementation and Clinical Tests of a Wire-Based Robot for Neurorehabilitation," *IEEE Transactions on Neural Systems and Rehabilitation Engineering*, vol. 15, no. 4, pp. 560–569, December 2007.
- [11] Y. Mao, X. Jin, G. Gera Dutta, J. P. Scholz, and S. K. Agrawal, "Human Movement Training With a Cable Driven ARm EXoskeleton (CAREX)," *IEEE Transactions on Neural Systems and Rehabilitation Engineering*, vol. 23, no. 1, pp. 84–92, jan 2015.
- [12] R. Gopura and K. Kiguchi, "Development of a 6DOF Exoskeleton Robot for Human Upper-Limb Motion Assist," in *2008 4th International Conference on Information and Automation for Sustainability*. IEEE, dec 2008, pp. 13–18.
- [13] E. Rocon, J. Belda-Lois, A. Ruiz, M. Manto, J. Moreno, and J. Pons, "Design and Validation of a Rehabilitation Robotic Exoskeleton for Tremor Assessment and Suppression," *IEEE Transactions on Neural Systems and Rehabilitation Engineering*, vol. 15, no. 3, pp. 367–378, September 2007.
- [14] C.-J. Yang, J.-F. Zhang, Y. Chen, Y.-M. Dong, and Y. Zhang, "A Review of exoskeleton-type systems and their key technologies," *Proceedings of the Institution of Mechanical Engineers, Part C: Journal of Mechanical Engineering Science*, vol. 222, no. 8, pp. 1599–1612, aug 2008.
- [15] T. Nef, M. Guidali, and R. Riener, "ARMin III arm therapy exoskeleton with an ergonomic shoulder actuation," *Applied Bionics and Biomechanics*, vol. 6, no. 2, pp. 127–142, 2009.
- [16] R. Sanchez, D. Reinkensmeyer, P. Shah, J. Liu, S. Rao, R. Smith, S. Cramer, T. Rahman, and J. Bobrow, "Monitoring functional arm movement for home-based therapy after stroke," in *The 26th Annual International Conference of the IEEE Engineering in Medicine and Biology Society*, vol. 4. IEEE, 2004, pp. 4787–4790.
- [17] M. Daas, "Toward a taxonomy of architectural robotics," *Blucher Design Proceedings*, vol. 1, no. 8, pp. 623 – 626, 2014.
- [18] E. Prestes, J. L. Carbonera, S. R. Fiorini, V. A. M. Jorge, M. Abel, R. Madhavan, A. Locoro, P. Goncalves, M. E. Barreto, M. Habib, A. Chibani, S. Gerard, Y. Amirat, and C. Schlenoff, "Towards a core ontology for robotics and automation," *Robotics and Autonomous Systems*, vol. 61, no. 11, pp. 1193 – 1204, 2013, ubiquitous Robotics.
- [19] M. Stenmark, J. Malec, K. Nilsson, and A. Robertsson, "On distributed knowledge bases for robotized small-batch assembly," *IEEE Transactions on Automation Science and Engineering*, vol. 12, no. 2, pp. 519–528, April 2015.
- [20] M. Tenorth, "Knowledge processing for autonomous robots," Dissertation, Technische Universitaet Muenchen, 2011.
- [21] E. A. Kirchner, N. Will, M. Simnofske, L. M. Benitez Vaca, B. Bongardt, M. M. Krell, S. Kumar, M. Mallwitz, A. Seeland, M. Tabie, H. Wöhrle, M. Yüksel, A. Heß, R. Buschfort, and F. Kirchner, "Recupera-Reha: Exoskeleton Technology with Integrated Biosignal Analysis for Sensorimotor Rehabilitation," *2. Transdisziplinäre Konferenz "Technische Unterstützungssysteme, die die Menschen wirklich wollen". Transdisziplinäre Konferenz "Technische Unterstützungssysteme, die die Menschen wirklich wollen", December 12-13, Hamburg, Germany*, pp. 504–517, 2016.
- [22] J. Hilljegerdes, P. Kampmann, S. Bosse, and F. Kirchner, "Development of an Intelligent Joint Actuator Prototype for Climbing and Walking Robots," in *Mobile robotics : solutions and challenges : proceedings of the Twelfth International Conference on Climbing and Walking Robots and the Support Technologies for Mobile Machines, Istanbul, Turkey, 9-11 September 2009*, 2009, pp. 942–949.
- [23] M. Simnofske, S. Kumar, B. Bongardt, and F. Kirchner, "Active Ankle—an Almost-Spherical Parallel Mechanism," in *Proceedings of ISR 2016: 47st International Symposium on Robotics*, June 2016, pp. 1–6.
- [24] S. Bartsch, M. Manz, P. Kampmann, A. Dettmann, H. Hanff, M. Langosz, K. v. Szadkowski, J. Hilljegerdes, M. Simnofske, P. Kloss, M. Meder, and F. Kirchner, "Development and control of the multi-legged robot mantis," in *Proceedings of ISR 2016: 47st International Symposium on Robotics*, June 2016, pp. 1–8.